

# A.caminetti

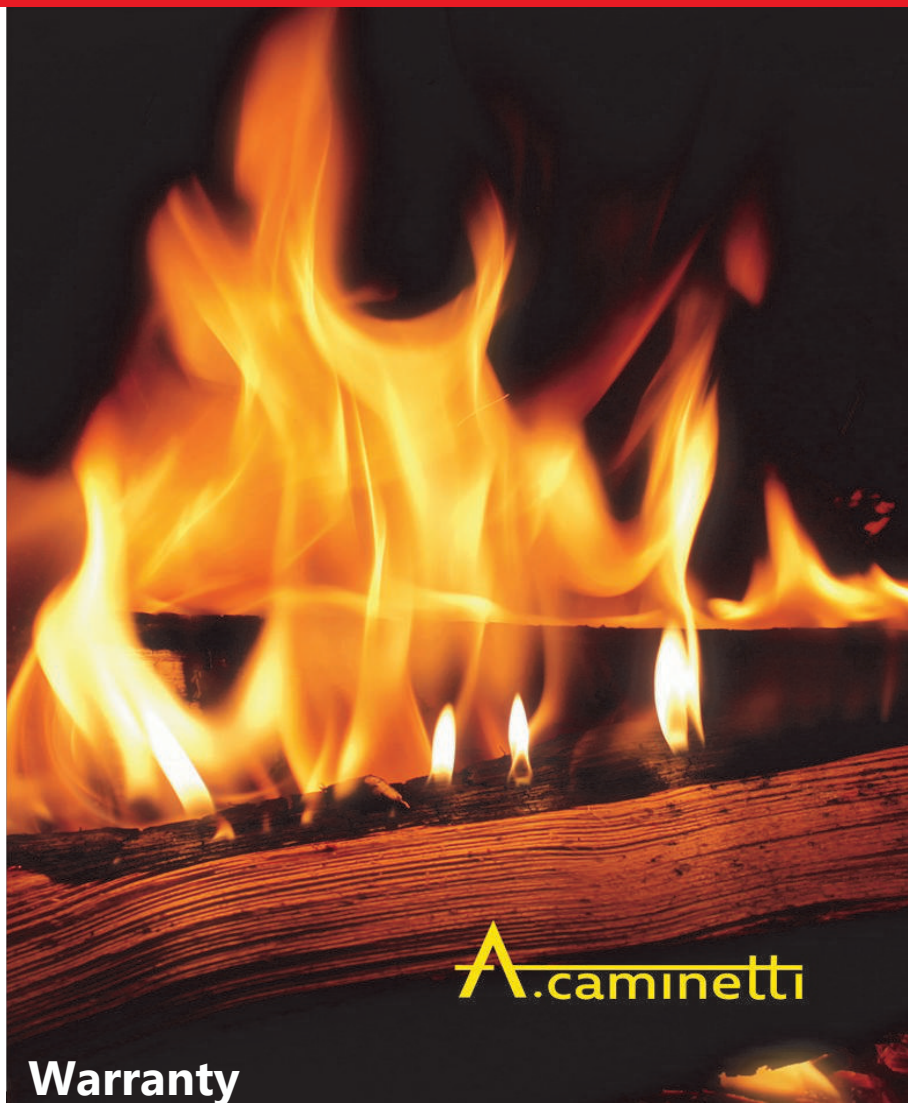

A.caminetti

**Warranty**

**Manual of use installation & operation**

[www.acaminetti-factory.com](http://www.acaminetti-factory.com)



1.	Introduction .....
2.	Installation instructions .....
	<i>Chimney - introduction</i> .....
	<i>Chimney outcome (hat)</i> .....
	<i>Installation space</i> .....
	<i>Air supply</i> .....
	<i>Power supply</i> .....
	<i>Ventilator installation</i> .....
3.	Operation instructions .....
	<i>Operation description</i> .....
	<i>Wood fuel</i> .....
	<i>Starting a fire</i> .....
	<i>Use of the device</i> .....
	<i>Opening of the door</i> .....
	<i>Stopping a fire</i> .....
4.	Maintenance and service .....
	<i>Cleaning of the chimney</i> .....
	<i>Combustion chamber cleaning</i> .....
	<i>Ceramic crystal cleaning</i> .....
	<i>Mechanism of lift door</i> .....
	<i>Safety distances</i> .....
5.	Troubleshooting .....
6.	General rules & guarantees .....
	<i>GUARANTEE</i> .....
	<i>SALES RECEIPT</i> .....
	<i>EXP WARRANTY</i> .....

## **Symbols which are used**



*This symbol indicates messages relative to information that are presented in the present or in the accompanying handbook and should be taken under consideration.*



***This safety symbol indicates messages relative to dangers that should be taken under consideration for the avoidance of accident.***



*This symbol indicates an indication.*

## Introduction



### **DO NOT DISCARD THIS MANUAL**

**Important operating  
and maintenance  
instructions included**

**Read, understand and follow  
these instructions for safe  
installation and operation**

Dear customer,

*A.caminetti* highly appreciates your choice of its product, a result of systematic study and embodying long-term experience on the fireplaces field since 1991. The product of *A.caminetti* has been designed to provide the utmost in safety, reliability and high efficiency.

*For your safety and better use of the fireplace, please read the users' manual thoroughly before installation and operation. Pay special attention to all cautions and warnings.*

*This manual should be retained for future reference. We suggest you keep it with your other important documents and product manuals.*

*The information contained in this manual unless noted otherwise, applies to all models and refers to the buyer-user of the appliance and anyone else implicated in the installation and maintenance.*

*Any change or intervention in the appliance except all mentioned in the present manual is forbidden.*

*The installer has to apply all the installation instructions that are mentioned in the present manual, to do the first start and deliver the appliance only if its function has been thoroughly understood by the final user.*



***The installation should be performed by well trained and qualified personnel.***



***If the information in these instructions is not exactly followed, a fire may result causing property damage, or personal injury.***

*A.caminetti is not responsible in any case of injury or property damage that may be caused from not applying the installation, operation, maintenance and safety instructions written in the present manual.*

Your new product will provide you with many years of trouble-free enjoyment!

# Installation Instructions



**WARNING! Installation MUST comply with all local regulations, including those relating to national and European standards.**

## **Chimney - introduction**

The chimney is the duct from where the extraction of the exhaust gas to the environment is performed at the burning devices with natural draught (fireplaces).

**The chimney diameter must be 200 - 250 mm.**

*The structure and the materials should be consistent with the safety rules.*

*It is forbidden to pass through staircases, skylights or ventilation ducts.*



**The passing of the chimney through the wooden roof is forbidden except if perimetrical of the duct an extra built wall with adequate heat insulation is constructed.**



**Wooden roof components perimetrical to the chimney duct should be placed at a distance  $\geq 70\text{cm}$ .**

*The advisable material for the construction of the chimney is stainless steel sheet metal. In between the duct an insulating material is placed, that conserves the temperature and helps the right draught and the avoidance of liquidation of the exhaust gas in the internal of its walls.*

*Every chimney should be connected to exclusively one appliance (fireplace)*

The internal diameter of the chimney should be consistent with the specifications of the manufacturer.

The profile of the chimney is advised to be circular because by this way the smooth flow of the exhaust gas is assisted, the friction is eliminated, and the attachment of burn products (smog, tar) at the walls is avoided.

In case of square or rectangular profiles, the corners should have a radius  $\geq 20\text{mm}$ .

The height of the chimney should be  $\geq 3,5\text{ m}$  from the top of the device (fireplace) and where a corner is needed to be constructed, this should be  $\geq 135^\circ$ .



**The common use of the same chimney with other appliances is prohibited.**



**No passing of water pipes, air conditioning or power cables inside the chimney is permitted.**



**A.caminetti assumes no responsibility in case of injury or property damage if the installation instructions of the chimney are not followed.**



**Using chimney with appropriate diameter ensures the avoidance of gases liquefaction (caused by from sudden temperature change) which affect both the function and long life of the device.**

## **Chimney outcome (hat)**

The chimney ending (hat) is the device at the end of the chimney and is used to prevent the inflow of foreign bodies inside the chimney and the smooth flow of the exhaust gases to the atmosphere.

The hat:

*Should be constructed of materials resistant to weather conditions (e.g. stainless steel).*

*If the closest obstacle to the chimney is a tree or an element inflammable and there is a danger of fire, then the minimum distance between the chimney and this element should be  $\geq 8\text{m}$ .*

*At buildings where more than one chimney ends, the height difference would be  $\geq 60\text{cm}$  to prevent inflow of smoke.*



***The hat of the chimney should be constructed so that it does not disturb neighboring buildings.***

## **Installation space**

The installation location is selected with criterion the safe use of the device, the position of the chimney and combustion air flow.

The installation and use of the device in bedrooms, bathrooms and stairwells is prohibited.

The use of the ventilation system while using the device in the same area is prohibited. There is a risk of vacuuming thus forcing the exhaust to get out from the device to the room.

The installation of the device in potentially explosive atmospheres is prohibited.

The use of the device in cooking areas where gas is used is prohibited.



***The use of device in places where there is a risk of fire is strictly prohibited.***

## **Air supply**

For the operation of the device it is necessary to provide ambient air to the combustion chamber of the device. Proper air flow ensures proper combustion.

*The air supply of the device should be compatible with the technical specifications of the device. (Ø 100-150mm)*

*If there is not direct air flow from the external environment then it can be obtained from adjacent areas that have contact with the outside environment via pipelines.*

*The duct system should be constructed from heat resistant materials. On the outer side of the air supply louvers should be mounted for blocking importation of foreign bodies, and the holes should be able to deliver the required amount of air to the device.*

*Make sure that during the operation of the device the air supply is not cut off*

## **Power supply**

In case the device has a ventilator, it should be connected to the power supply in a distance  $\geq 1\text{m}$  from the device through insulated

conductor for protection. To start or stop operation of the ventilator a switch should be installed at a safe distance from the device radiation area or alternatively a wall digital controller.

*A silicone cable is recommended for the ventilator connection.*

*All necessary measures to protect electrical connections from the heat emitted by the device should be taken.*

*The installation of outdoor decorative lighting to the device is only permitted if the risk of fire from overheating or the short circuit of wires is eliminated.*

*The facility should include grounding and electrical safety board, as defined by the technical regulations.*

*The electrical connection should be done only by experienced and qualified personnel.*

## **Ventilator installation**

*If hot air is transferred from the device in adjacent rooms, the length of the pipelines should be  $\leq 10\text{m}$  with the existing pipe profile  $\text{Ø}100\text{mm}$ .*

*The operation control of the ventilator is done by a digital wall thermostat (optional).*

*The hot air transfer ducts should be made of smooth stainless steel tube.*

*To reduce heat losses it is proposed to insulate the hot air transfer duct.*

*To connect the fan with the internal air it should be used a hose of a  $\text{Ø}150\text{mm}$  diameter at both entrances of the ventilator.*



***The electric connection should be performed only by an experienced electrician.***

## Operation Instructions



**WARNING! DO NOT operate fireplace before reading and understanding operating instructions. Failure to operate fireplace according to operating instructions could cause fire or injury.**



**WARNING! High temperatures may ignite clothing or other combustible materials. Keep clothing, furniture and other combustible materials away.**

### **Operation description**

#### Environment air:

The environment air is necessary for the start of combustion. The air enters to the combustion chamber in order to take place the combustion by opening the «lever» in the bottom of the thermodynamic fireplace. Close the «lever» when combustion is good enough. Repeat only if you want to increase the fire.

#### Secondary air:

The secondary air used for two reasons:

1. For the gases afterburning created during the combustion of the combustible materials. It helps burn the carbon dioxide so that there is less pollutants emission.
2. Creates an air «curtain» near the glass so to keep it clean from exhaust.

## Wood fuel

The device is designed to operate only with wood fuel.

*Properly seasoned wood is important for successful operation of your fireplace. Most woodburning fireplace problems are caused by burning wet, unseasoned wood. Seasoned firewood is wood that is cut to size, split and air dried to a moisture content of around 18%.*



**We recommend buying the woods during summer months.**

*The continuous use of wet wood is causing pollution to the device and ceramic glass with tobacco and tar residues and fast blockage of the chimney.*

*The wood that is recommended is: beech, oak. Avoid resinous wood like pine, fir, and soft resin wood such as poplar, willow because they burn quickly releasing soot resulting fast blockage to the chimney. Prefer wood with high consistency and weight to ensure constant and intense flame.*



**WARNING! Risk of Fire! DO NOT burn wet or green wood.**



**WARNING! Fire Risk! DO NOT store wood:**

- x **In front of the fireplace.**
- x **In space required for loading or ash removal.**



**The use of wood fuel that causes small explosions is forbidden. There is risk of ceramic glass breakage and injury.**



**Burning of painted wood, chipboard, paper, plastics is forbidden. There is risk of damaging the chimney and environmental pollution.**



**The use of any liquid fuel is forbidden.**

In addition:

*Do not place the wood on the walls and the ceramic glass of the device. Do not stack much wood, place it in a way that it gets air and thereby proper combustion is ensured.*

## Starting a fire



**WARNING! Risk of Fire! Keep combustible materials, gasoline and other combustible vapors and liquids away from the fireplace.**



**DO NOT:**

- x **store combustible materials close to the fireplace**
- x **use gasoline, liquid fuels, kerosene or similar liquids to start a fire or during the fireplace is in use.**

After installing the device the first test lighting should be performed to determine the correct installation and operation of the fireplace.

The first lighting should be done by the installer.

For the first lighting wood fuel should be used in quantities less than 50% of the nominal consumption of the device.

The first three or four fires should be of moderate size to allow the painting materials to be dried from the fireplace and paint to cure. You may notice an industrial smell during the first few fires. This is considered normal.

*Ventilate the area leaving a window open.*

*If the device has a ventilator, it should be set under operation.*

*Use twisted paper on the fireplace grate.*

*Arrange kindling or small pieces of wood to form a 'tent' on the fireplace grate.*

*Light the paper to ignite the kindling.*

*Add small pieces of wood until a hot bed of coals has been established.*

*Add a minimum of three average size pieces of firewood (and not more than six), placed to allow combustion air and flames between them.*



**CAUTION! Smells and vapors released during initial operation may be irritating to sensitive individuals. Open windows for air circulation.**



**CAUTION! There is a risk of vacuum in places where operates controlled ventilation systems, hood (kitchen, bathroom) without any recycling air systems.**



**CAUTION!** During combustion the surface of the glasses and the coating will get hot and will burn. **RISK OF BURN**



**WARNING!** DO NOT throw the wood pieces with force in the fireplace. There is danger of crack or chink of the firebricks.



**In no case stop the fire with water. There is danger of causing damage to the device.**



**Do not remove the burning wood from the device. There is danger of causing personal injury or fire.**



**WARNING! Risk of Fire! Use only the factory-supplied grate:**  
x **Allows proper air circulation around the fire.**

## **Use of the device**

The device you have purchased is designed to heat with minimized fuel consumption. To achieve this, you must configure and operate the device properly.

Follow the instructions for proper use of the device:

*During lighting make sure the space is clean and burning remains (ash-extinguished coals) from the previous combustion have been removed. The clean device facilitates air circulation between the wood and proper combustion.*

*For firelighter use some paper or ready trade kindling.*



**Do not use liquid fuel for firelighter.**



**Place the wood fuel in a way that reduces the risk of falling outside the device or resting on the ceramic glass. There is a risk of fire.**

## **Opening of the door**

*The door should be opened slowly and be left half opened for some time (before fully open) to prevent any vacuum.*

*Always use a glove that is provided with the device because many metal parts of the device develop high temperature and there is a risk of burning.*

The door should open on the side only if the ceramic glass is required to be cleaned.



**Do not open the door if the device operates in the same room with air suction devices (hood, ventilation) because there is a case the smoke enters to the space from the fireplace.**



*Prolonged use of the device causes more tar accumulation in the chimney and at the ceramic glass demanding a more frequent cleaning.*



**WARNING! Do not leave the device with the door open. Danger of fire resulting from sparks or coals that may fall out of the device.**



**WARNING! Use only firewoods and no firewoods from coniferous trees which have resin.**



**WARNING! Make sure you do not leave access to young children, while the door is open.**

## **Stopping a fire**

The stopping of the fire is done only when the entire amount of wood in the fireplace is consumed.

Separate the pieces of wood to stop the fire.

If you wish to stop the fire immediately, you can adjust the air flow in the closed position.

The fire due to lack of oxygen will stop.



**In case of fire use a fire distinguisher.**



## Chapter

# 4

## Maintenance and service

For long-term economic and safe operation of the device the maintenance instructions provided in this manual should be faithfully performed.

Thorough inspection and maintenance of the device should be held annually before the start of the season (autumn).

-  *All cleaning - maintenance work should be performed with the device stopped and the ash cleaned.*
-  *Maintenance should be performed by qualified individuals.*



**WARNING! Except from programmed annual maintenance, additional inspections should also be performed.**

### **Cleaning of the chimney**

-  *Remove the tar and the soot from the walls of the chimney using a special brush.*



**WARNING! Cooking food is not recommended due to the fats that stick at the walls of the chimney with possible risk of self-ignition and fire.**



**WARNING! Chemicals for the separation of soot are not sufficient to clean the chimney**







**WARNING! The accumulated tar can be self-igniting. Carry out regular inspection and cleaning of the chimney.**

## Combustion chamber cleaning

You should perform daily cleaning of the interior of the combustion chamber, because accumulated ash may reach up the grill and may gradually cause malfunction of the chamber.

The ash pot underneath the grill should also be cleaned every day. In case the container fills the air supply to the wood may be cut off resulting poor combustion and soot accumulation in the chamber.

-  *The cleaning is done with the device stopped.*
-  *Remove the ash, after making sure that there are no burning coals.*
-  *Use a metal container for ash removal. Before emptying the container into the trash, hold it in place away from flammable materials to make sure it is fully extinguished.*
-  *The coals that are outside from the fireplace can cause fire.*



*The grate and the ash pot are consumables and may need replacement after 3-4 seasons of operation. Check the sale points for the supply of the spare parts.*

## Ceramic crystal cleaning

To clean the ceramic glass you should open the door to the side. Use the key provided for the side opening of the door.



**WARNING! The cleaning of the crystal is performed when the device is stopped.**



**WARNING! Do not use materials that can scratch the glass. The engraving can be converted into crack.**

The crystals that **A.caminetti** is using are ceramic with 4mm thickness (**SCHOTT ROBAX®**) with very high resistance to thermal shock 800°C and high elasticity. But it can be broken by a strong hit.

**MECHANISM OF THE LIFT DOOR:** A sophisticated slide mechanism guarantees a permanent quite and light movement of the door. The door slide in a close chamber over the door and does not restrict the living room in this way. The precise movement of the door at high operating temperature is guaranteed by two ball bearing slide for fireplaces door (produced by: [schock-metall.de](http://schock-metall.de)), which are resistant for a temperature over than 350 °C. This bearings guide the door movement exactly and permanently.

## **Safety distances**

The zone around the fireplace: at least one meter around the fireplace, there must be no combustible material e.g. carpet, wooden furniture, curtains and any flammable liquids or materials igniter.

*Regulate the air exits (blinds) of the hot air so that they do not have direction on sensitive materials (curtains, curtain rods).*

## Chapter

# 5

S/N	Start Fire Problems	Possible Cause	Solution
1	Can't get fire started	The wood is too wet.	Use dry kindling, smaller and dryer wood.
		The air regulator is closed.	Open the air regulator.
2	The chamber lets out excessive smoke when the door gets open	The door opens very quickly.	Open the door more smoothly letting it half open before you entirely open it.
		There is another suction device at the same place.	Close all the suction devices.
		The chimney has been blocked.	Check and clean the chimney if needed.
		The profile of the combustion air inlet duct is small.	Increase the profile of the combustion air inlet duct.
3	The chamber lets out excessive smoke when there are bad weather conditions.	The chimney is not insulated.	Insulate the chimney properly.
		The chimney does not have the proper height.	Raise the chimney to the proper height, higher from possible obstacles.
4	The ceramic glass is excessively smoky	Inappropriate wood.	Use appropriate wood.
		Inappropriate convection.	Chimney inspection.
		Wet wood.	Use dry wood.
		Inadequate combustion air.	Open the combustion air regulator.

S/N	Start Fire Problems	Possible Cause	Solution
5	The fireplace does not warm the space	Inadequate volume of wood.	Use the right volume of wood (see technical characteristics)
		Inappropriate size of device for the space to be warm with.	Choose the appropriate size of device or combine with other warming means.
		Inadequate space insulation.	Insulate the space appropriately.
6	The ventilator does not operate	Wrong connection.	Check the wire connections.
		Thermostat breakdown.	Check or replace the thermostat.
		Ventilator breakdown.	Check the ventilator.
		Power supply interruption.	Check the power supply.

## **General rules and guarantees**

This product is an achievement of high quality and latest technology. The used materials were selected carefully and underlie to continuous checks. For the installer disassemble this product special knowledge require. For that reason, our products must be installed and put into operation only by qualified personnel.

### **GUARANTEE**

*For our products we guarantee the following: Fireplaces **5 years***

*The present warranty is valid from the delivery (Date & receipt).*

*There is a guarantee of 12 months for the consumable materials as the firebricks, insulations and glass, as well as other parts such as handles, electrical parts.*

### **SALES RECEIPT**

The date of purchase must be shown on the bill and receipt. Without these certificates we are not obliged to comply with the guarantee.

### **EXP WARRANTY**

The warrantee does not stand in the case of:

*consumable materials.*

*Seal: Reduction of insulation due to thermal strain.*

*Glasses: Stains cause by soot or debris burned materials, as well as discoloration or any other deterioration due to thermal strain.*

*Errors during transport - storage.*

*Improper operation and handling..*

*Inadequate maintenance.*

*Faulty installation or connection of the device. The installation should be done by the team recommended by the supplier of the fireplace.*

*Ignore the installation and operating instructions.*

*Technical alterations to the appliance by a third party not connected with our company.*



*Even after the end of the warranty, we will be pleased to help you and give you the proper information. We reserve the right for technical changes and mistakes.*

## **AIR CONTROL LEVER**



All the A.caminetti fireplaces are equipped with one air control lever. The fire immediately response to every movement of the control lever. High combustion temperature in the firebox does not effect the safety and the control comfort. Control elements are designed to be self cooling during the operation. Next to design paid much attention to simplicity of control. They are characterized by pure shapes and intuitive control.

## FAN & SENSOR INSTALLATION



All the A.caminetti fireplaces except the Flat Tunnel model and 4D model are with hot air system. The fan and the remote kit control are Italian brand Tiemme.

## **DOOR OPENING**



All the A.caminetti fireplaces are with lift door and also they have side opening, that is for glass cleaning.

## GRILLE CROSS - SECTION

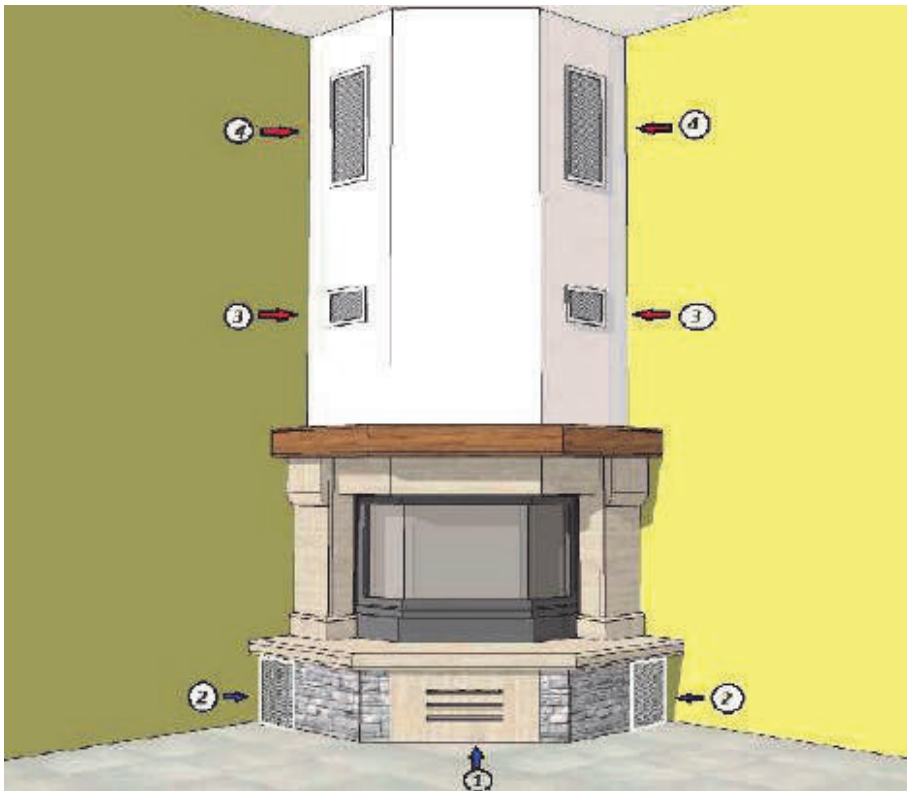

**1)** The grille no 1. You must install it like in the picture and it must be movable. In this way you can check the fan. This grille is to supply naturally the thermal chamber, and to check the ventilator. The minimum cross-section 450 x 220 mm.

**2)** The grille no 2. These grilles are connected with the fan to suck the air of the environment. The minimum cross-section for each is 200x200 mm.

**3)** The grille no 3. These grilles are for outgoing hot air connected with the ventilator. Minimum cross-section for each is 200x200 mm.

**4)** The grille no 4. These grilles are designed to release naturally the temperature created in the thermal chamber. Minimum cross-section for each 250x200 mm.

**! WARNING****installation planning**

- Wear gloves, protective footwear and safety glasses for protection.
- Carefully follow the instructions for assembly of the pipe and other parts needed to install the appliance. Failure to do so may result in a fire, especially if combustibles are too close to the appliance or chimney and air spacers are blocked, preventing the free movement of cooling air.
- Do not draw outside air from garage spaces. Exhaust products of gasoline engines are hazardous. Do not install outside air ducts such that the air may be drawn from attic spaces, basement or above the roofing where other heating appliances or fans and chimneys exhaust or utilize air. These precautions will reduce the possibility of appliance smoking or air flow reversal. The outside air inlet must remain clear of leaves, debris, ice and/or snow. It must be unrestricted while appliance is in use to prevent room air starvation which can cause smoke spillage and an inability to maintain a fire. Smoke spillage can also set off smoke alarms.
- Negative pressure within your home may inadvertently affect your appliance.
- To prevent contact with sagging or loose insulation, the appliance must not be installed against vapour barriers or exposed insulation. Localized overheating could occur and a fire could result.
- Do not use makeshift compromises during installation. Do not block or restrict air, grille or louvre openings. Do not add a hood.
- To prevent personal injury, keep hand tools in good condition, sharpen cutting edges and make sure tool handles are secure.
- Always maintain the minimum air space required to the enclosure to prevent fires.
- Check with local building officials for any permits required for installation of this appliance and notify your insurance company prior to proceeding.

**! WARNING**

- Do not install into any area having a height less than 2.5m (ceiling of enclosure to appliance bottom, excluding hearth height).

**ventilation openings**

The appliance enclosure must be provided with sufficient air circulation to avoid a fire hazard. Install ventilation grilles (minimum free air opening of 0.1 (sqm) at both floor and ceiling levels of the enclosure. These grilles must not restrict the flow of heat by more than 25%. Do not install into any area having a height less than 2.5m (ceiling enclosure to appliance bottom, excluding hearth height).

## floor protection / ember strip and hearth extensions

### ! WARNING

- Hearth extensions are to be installed only as described to prevent high temperatures from occurring on concealed combustible materials. Hearth ember strips prevent burning or hot particles from inadvertently falling directly on combustible surfaces in the event the building should settle and disturb the original construction.

An acceptable non-combustible (ie: brick, stone or ceramic tile) hearth extension that meets the criteria outlined in this section must be installed.

Hearth must extend 20" (50.8cm) in front of the fireplace when it is not elevated (see local building codes). Hearth must extend a minimum of 12" (30.5cm) to both sides of the appliance faceplate.

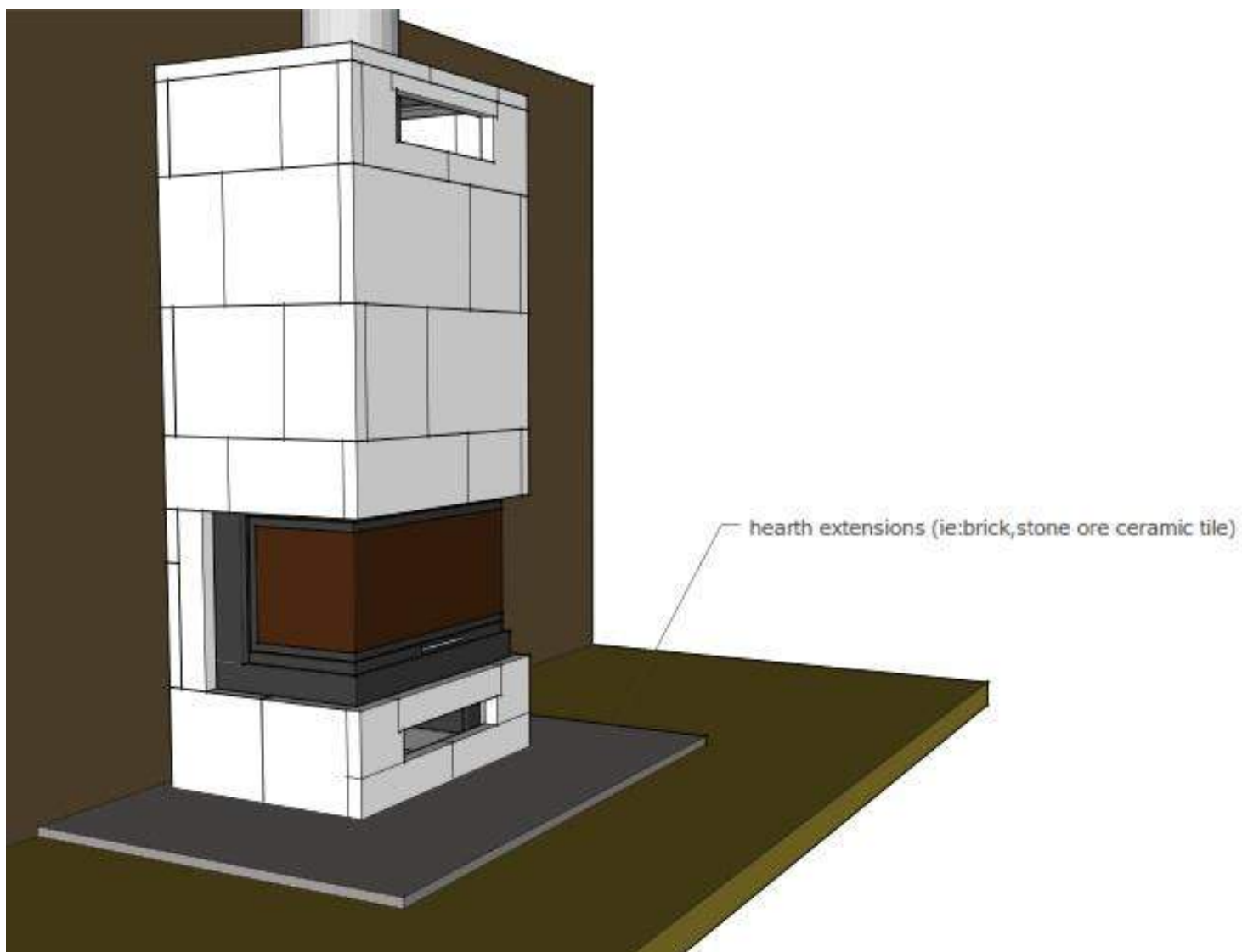

## typical chimney installation (8" solid packed or air cooled chimney)

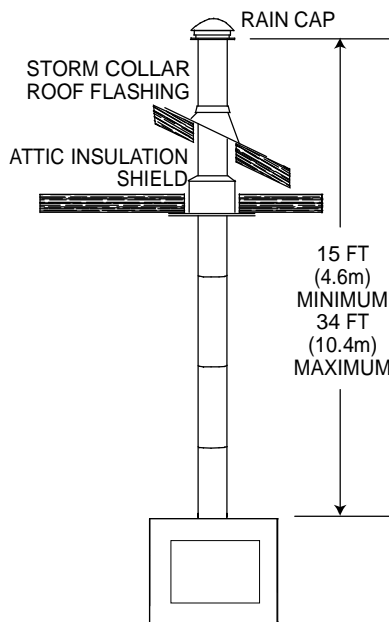

**STRAIGHT CHIMNEY**

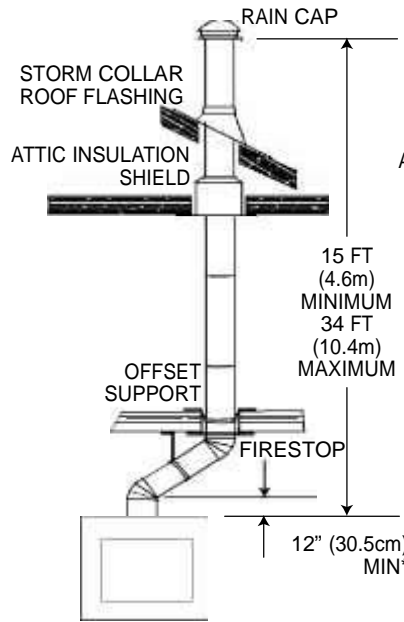

**SINGLE OFF-SET CHIMNEY**

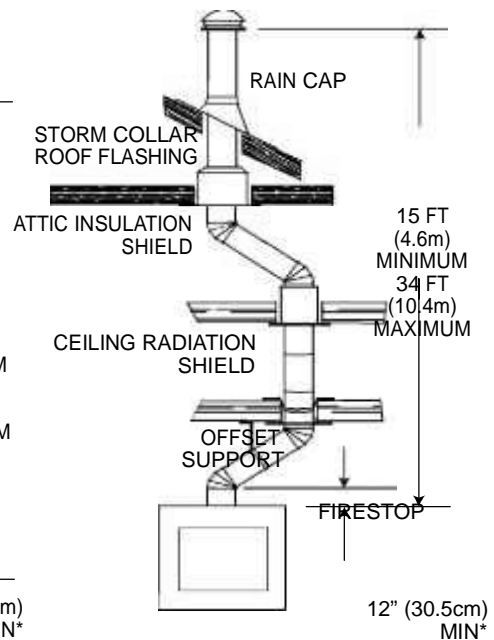

**DOUBLE OFF-SET CHIMNEY**

\* The first flue offset closest to the top of the appliance must be a minimum distance of 12" (304.8mm) from the top of the appliance.

- A. Move the appliance into position. Try to center the exhaust flue of the appliance, midpoint between two joists to prevent having to cut them. Use a plumb bob to line up the centre.
- B. Cut and frame an opening in the ceiling to provide a minimum clearance of 2" (50.8mm) between the outside of the chimney and any combustible material. **DO NOT FILL THIS SPACE WITH ANY TYPE OF MATERIAL!** Nail headers between the joists for extra support. Firestop spacers must be placed on each framed opening in any floor or ceiling that the chimney passes through.
- C. Hold a plumb bob from the underside of the roof to determine where the opening in the roof should be. Cut and frame the roof opening maintaining proper 2" (50.8mm) clearances.

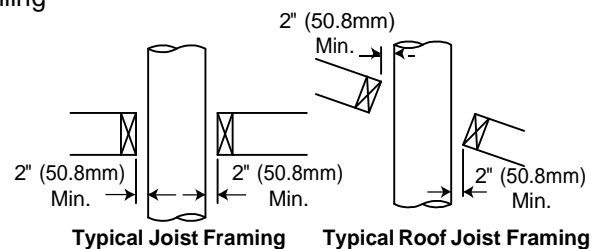
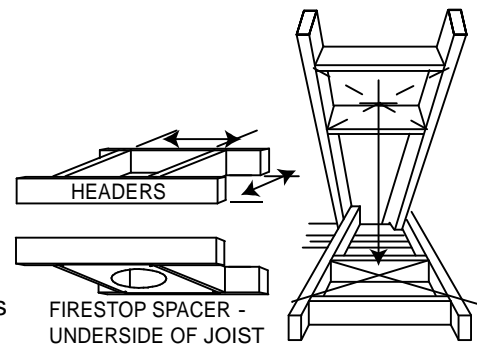

## adding chimney sections

Add chimney sections, according to the manufacturers installation instructions. If the chimney system passes through an attic space a rafter radiation shield or attic insulation shield is required. The chimney must extend at least 3ft (0.9m) above its point of contact with the roof and at least 2ft (0.6m) higher than any wall, roof or building within 10ft (3.1m). If the chimney extends more than 5ft (1.5m) above the roof, it must be secured using a roof brace or guide wires. A raincap must be installed to avoid internal damage and corrosion.

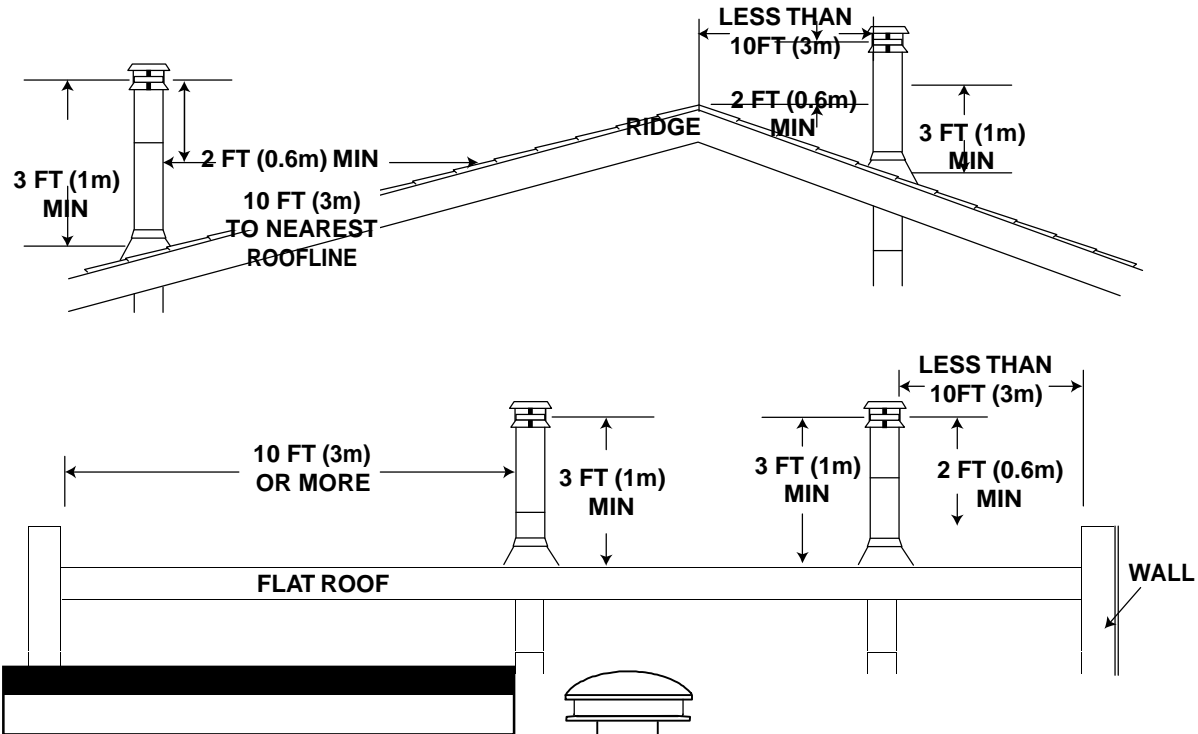

This illustration is for wood appliances only

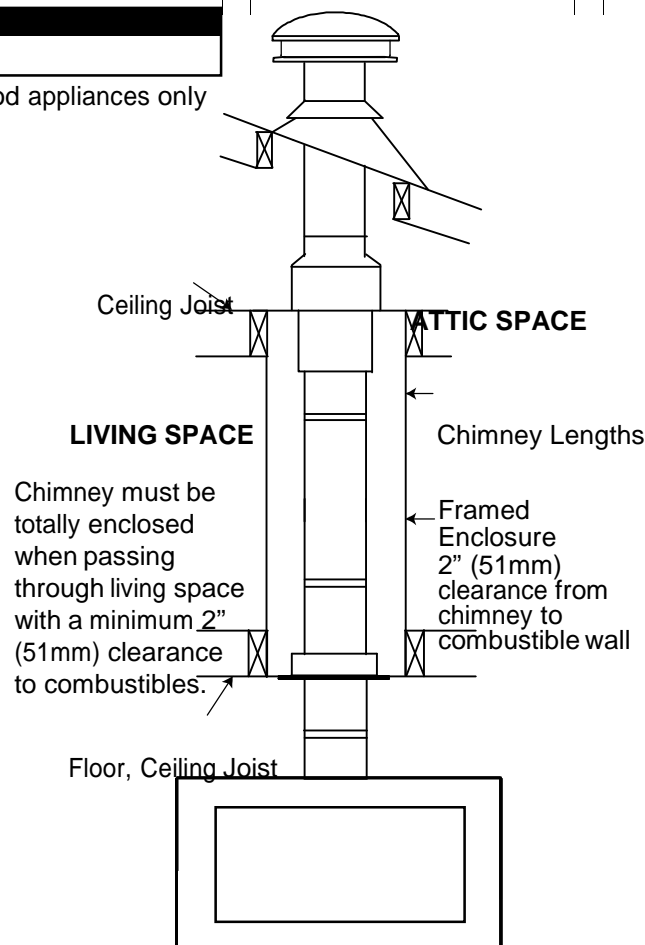

## offset chimney installation

### ! WARNING

- Chimney sections installed between an offset and return require structural support to reduce off-center loading and to prevent chimney sections from separating at the chimney joists.

The first flue offset closest to the top of the appliance must be a minimum distance of 12" (30.5cm) from the top of the appliance.

Attach an elbow to the chimney section, angled toward the offset. Secure according to chimney manufacturer's instructions. Chimney sections must be adequately secured one to the other to ensure they do not separate. To achieve the minimum offset, attach and secure a second elbow. To achieve longer offsets, you may install any available length of chimney pipe between the elbows. Supports must be used on the first vertical chimney section after a return elbow.

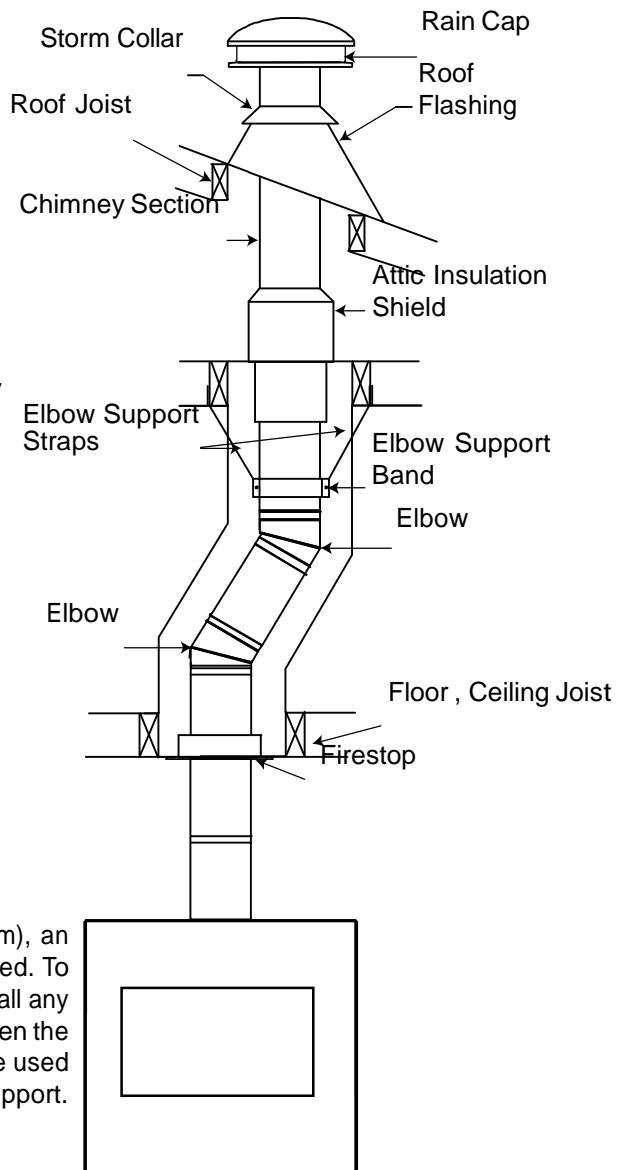

If the offset length is more than 36" (91.4cm), an intermediate support must be employed. To achieve longer offsets, you may install any available length of chimney pipe between the elbows. The intermediate support must be used in conjunction with an offset support.

## framing finishing material

### ⚠ WARNING

- Do not pack air spaces with insulation or other materials.
- Use only a non-combustible material to finish the face of the appliance. A non-combustible material such as **Calcium silic board** is required for this purpose.
- Ventilation openings are mandatory for enclosures.
- Do not insulate around the appliance.

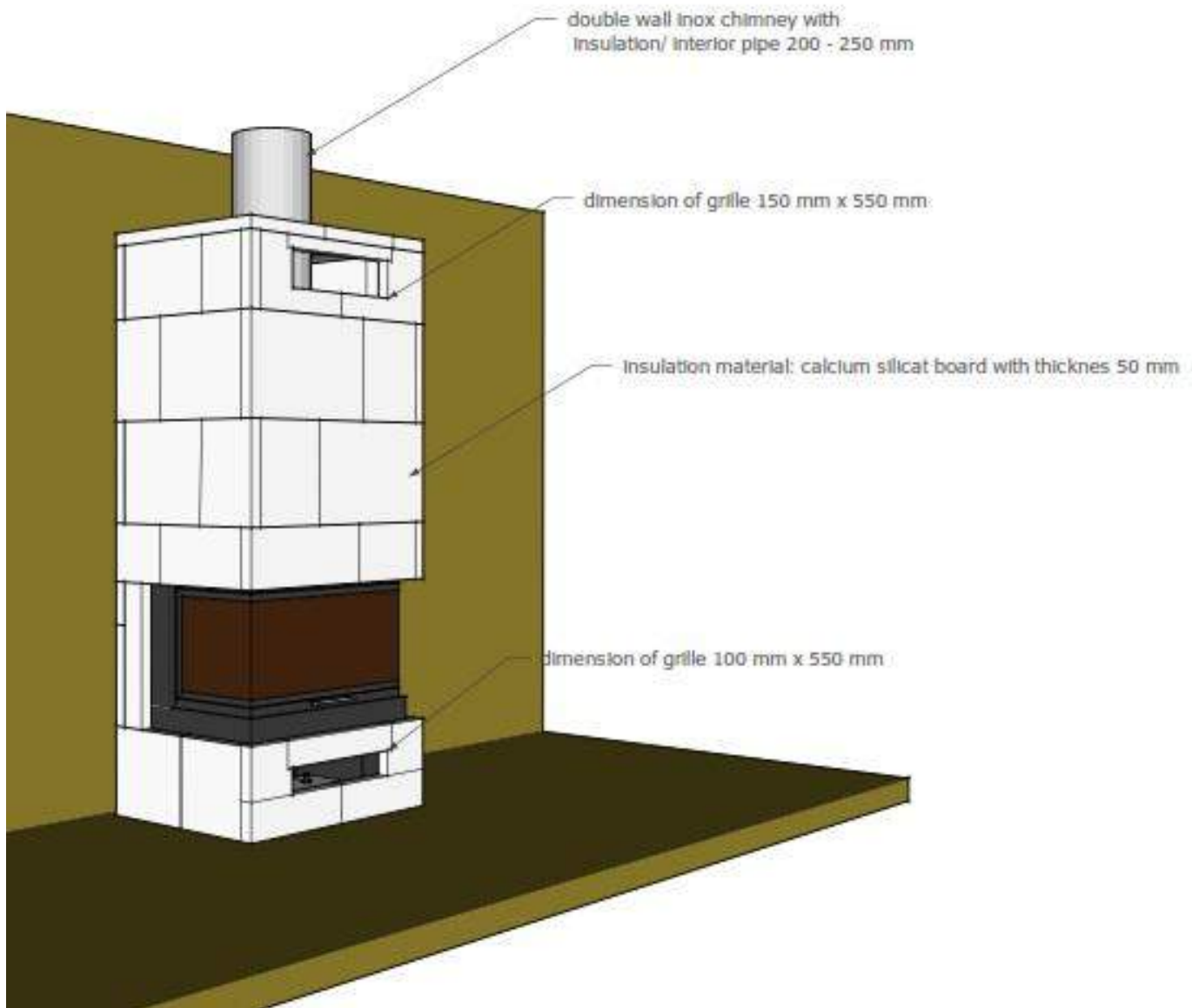

## outside combustion air

It is recommended to install outside air to the appliance as this will help to prevent any smoke entering the living space in homes that experience negative pressures. Check with local authorities having jurisdiction in your area, it may be mandatory.

Insulating the intake liner is recommended in colder climates to prevent condensation from occurring.

It is recommended that a dip or loop is put into the duct creating a cold air trap in order to prevent cold air from flowing into the room when the appliance is not being operated

The fresh air inlet duct and hood must be installed lower than the firebox.

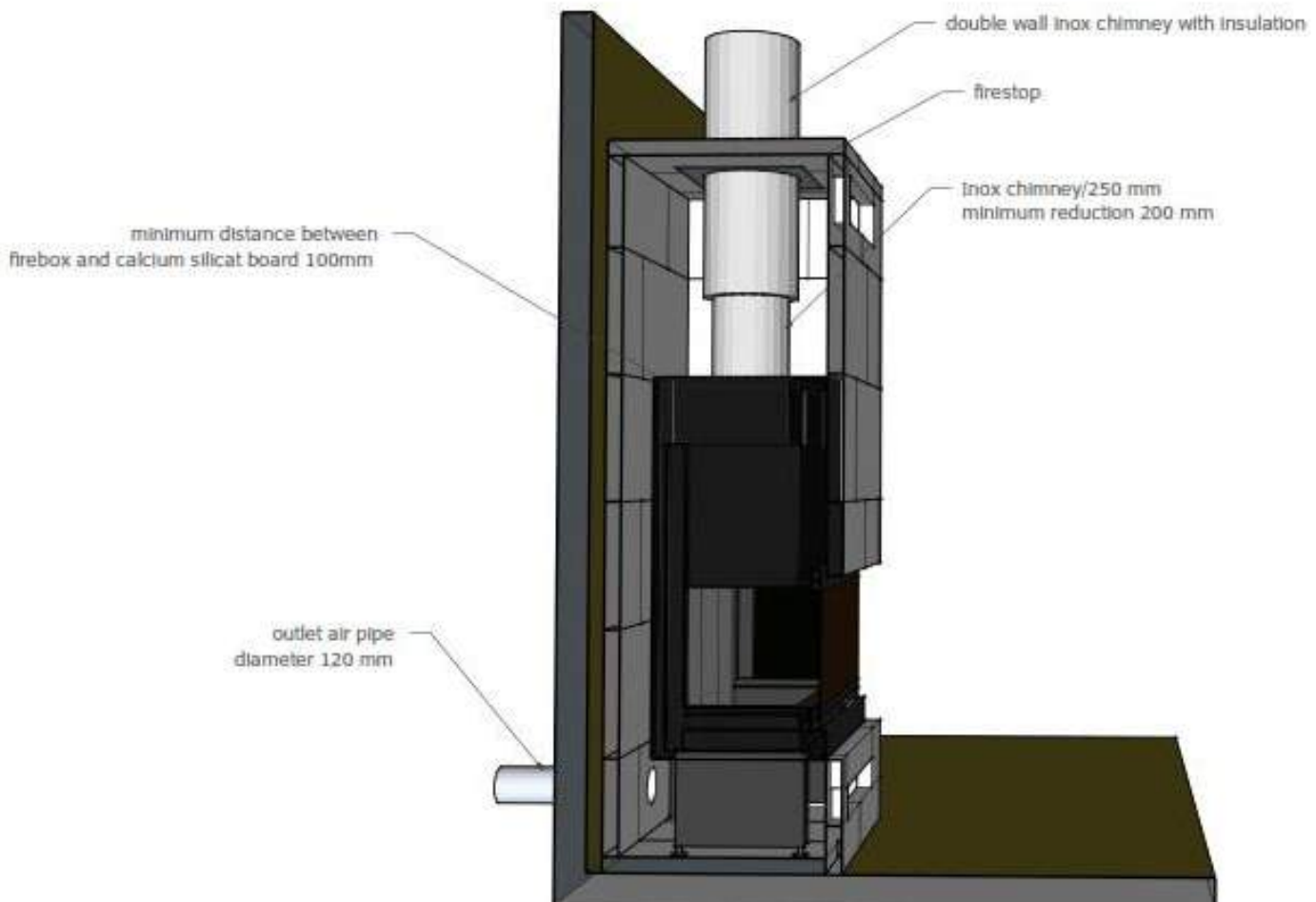

## Lighting and fueling (see photos)

1) open the door completely and start by placing approximately 1 kg wood – e.g two pieces split wood knot and add in the middle loosely 2-3 firelighters or similar – (photo1) in the bottom of the burning chamber. Add approx. 1,2 kg dry firewood (photo2), split two kindling sticks.

Light the fire (photo 3+4)

Close the door completely and move the lever (air control) in the open position completely right.(photo5)

When the last flames are extinguished and there is a good layer of embers (photo6) can be filled up to 3-4 pieces of wood – approx. 3 – 4 kg. (never more than 4 kg, moisture 18- 20 %) photo7

## FIRE ENVIRONMENTALLY FRIENDLY !

### 5 Eco- friendly advices for sensible heating

- common sense both environmentally and economically.

1) Effective lighting. Use small pieces of wood (fir tree) and a suitable fire lighter, for example paraffined wood wood/sawdust. Open the lever so plenty of air is fed to the fireplace and the gases from the heated wood can burn rapidly.

2) Light the fire with only little wood at time – this gives the best combustion, remember plenty of air for every time new wood is added.

3) When the flames are diminished, adjust the air lever so that the air supply is reduced.

4) When only glowing embers remain air flow can be reduced further so heating demand is just covered with lower air supply, the charcoal will burn slower and the heat loss through the chimney is reduced.

5) Use only dry wood – ie. wood with humidity of 18-20%.

## Lighting and fuelling



## Lighting and fuelling





25-33 cm/10-13"



Ø 4-10 cm/1,5-4"

**2 kg**



**Max 4 kg**



**Wood pallet**



**Carton**



**Coal**



# TECNOLOGIA DEL FUOCO